

Multifunction PERFORMANCE and DL18

Product reference : PERFORMANCE 90-60-182 - DL18 90-60-340

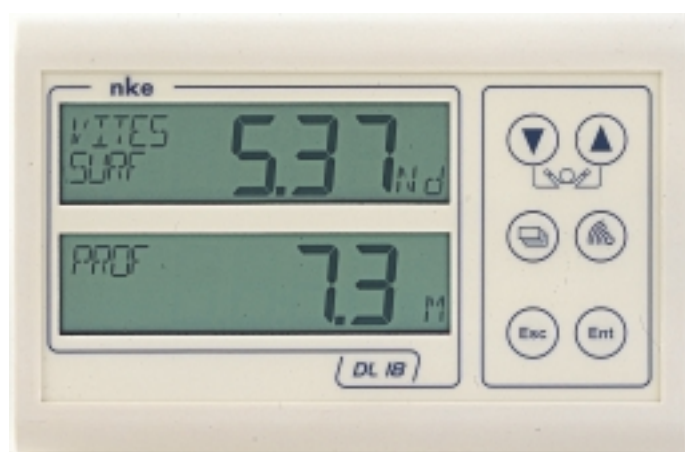

USER GUIDE and INSTALLATION GUIDE

nke - Sailing competition

Z.I. Kerandré – Rue Gutenberg – 56700 HENNEBONT- FRANCE
<http://www.nke.fr> – After sales service tel : 0 892 680 656.

SOMMAIRE

1	USING THE DEVICE	3
1.1	PRESENTATION.....	3
1.2	LIST OF CHANNELS CREATED.....	5
1.3	FUNCTIONS OF THE REMOTE CONTROL KEYS	6
1.4	CHANNEL SELECTION	7
1.5	WHAT IS A SUB-CHANNEL ?.....	7
1.6	ALARMS SETTING	8
1.7	FILTERING OF THE CHANNELS.....	10
1.8	LIGHTING SETTING	11
1.9	CHOICE OF THE UNIT	11
1.10	ZERO SETTING OF THE DAILY LOG	12
1.11	CHOICE OF LANGUAGES.....	12
1.12	USE OF THE CHRONOMETER.....	13
1.13	TREND AND POSITION INDICATORS.....	14
1.14	TECHNICAL SPECIFICATIONS	15
1.15	SOFTWARE VERSION	15
1.16	DIAGNOSTIC OF 1 ST LEVEL TROUBLESHOOTING.	15
1.17	<i>PERFORMANCE AND DL 18</i> INITIALISATION : SEE CHAPTER 3.6.....	15
2	SENSOR CALIBRATION.....	16
2.1	SETTING PROCEDURE FOR THE CALIBRATION COEFFICIENT	16
2.2	OFFSET SETTING PROCEDURE.....	16
2.3	AUTOCOMPENSATION OF THE FLUXGATE COMPASS.....	17
3	INSTALLATION	18
3.1	PACKING LIST	18
3.2	LIST OF ACCESSORIES	18
3.3	INSTALLATION PRECAUTIONS.....	18
3.4	WALL MOUNTING.....	18
3.5	CONNECTION TO THE <i>TOPLINE BUS</i>	20
3.6	<i>PERFORMANCE AND DL 18</i> INITIALISATION	21

1 USING THE DEVICE

1.1 Presentation

The **Multifunction PERFORMANCE** and the **Multifunction DL18** are displays from the **TOPLINE** range. Their two display lines, with high definition LCD technology, offer excellent readability and a wide angle of view of the data displayed, whether by daylight or at night. They are connected to the **TOPLINE bus** of your installation and display all the channels available on the bus.

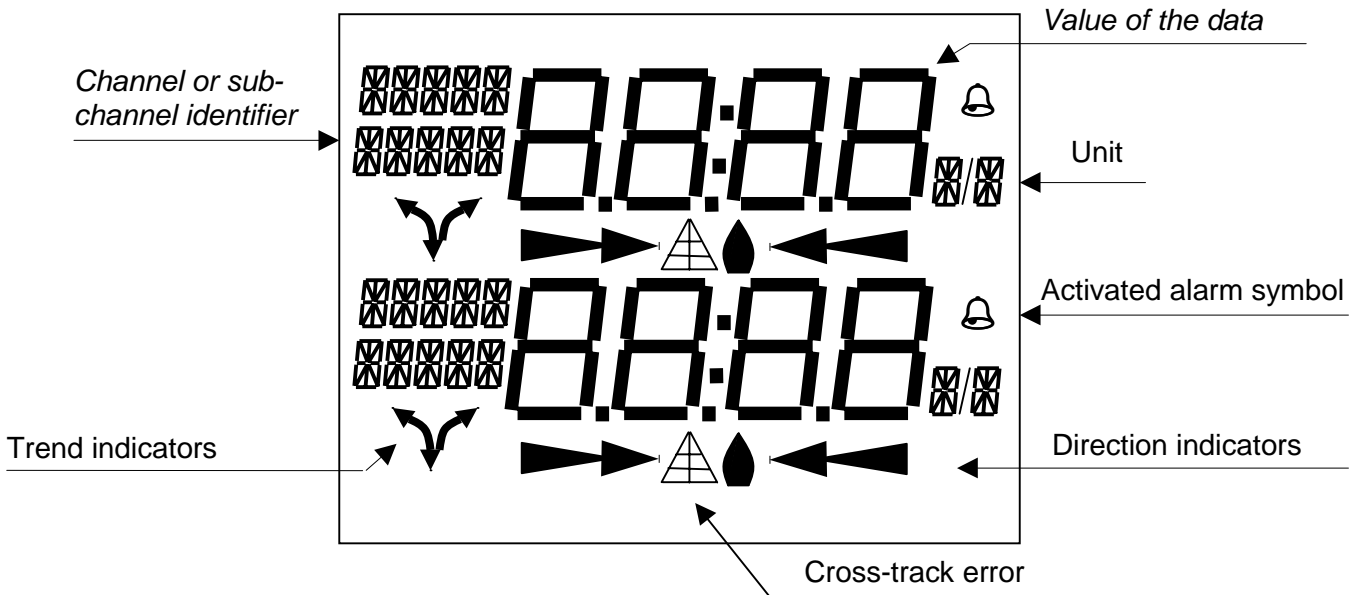

The **PERFORMANCE** is different from the **DL18** in that it displays trend and direction indicators (chapter 15), it displays the position, and it also publishes the performance channels (chapter 23).

Architecture of the installation

The presence of the equipment in the following diagram is for information only, and does not represent the equipment of your installation.

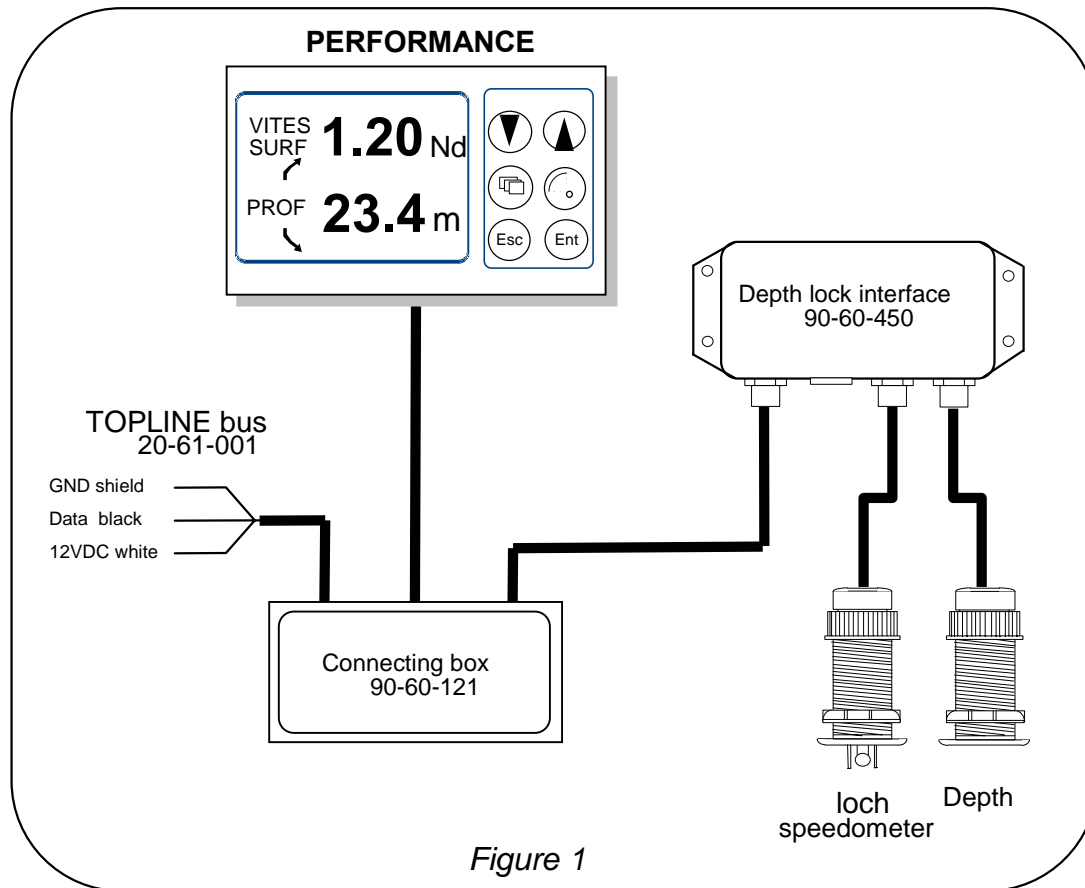

1.2 List of channels created

The master display, whether it is the **Performance, the DL18** or any other **TOPLINE** display, and each **TOPLINE** sensor, automatically create their respective channels when they are connected to the **TOPLINE** bus. Please refer to the user guides of the sensors and instruments to identify their channels.

	Channel designation
Channels created by the Performance and the DL18 , when set as master displays	Magnetic heading
	Apparent wind angle
	Apparent wind speed
	Depth
	Surface speed
	Maximum and average speed
	Distance and heading to man over board
	Configuration
	Bus voltage
	VMG
	CMG
	True wind speed
	True wind angle
	True wind direction
	Corrected heading
	Estimated distance
	Estimated angle
	Total log
Daily log	
NMEA channels displayed by DL18 and Performance	Bottom speed and bottom heading
	Cross-track error
NMEA channels displayed by performance	Longitude and latitude
NMEA channels displayed by the Performance	Optimum wind angle
	Optimum VMG angle
	Optimum CMG angle
	Efficiency at close-haul
	Polar efficiency
	Target speed
Heading on other side	

Please note that the **MAX SPD** and **AVRG SPD** channels are displayed alternatively on one single screen. By default, this channel is calculated using the surface speed, and in the absence of the latter it will be calculated using the bottom speed. These average and maximum values are calculated from the time your installation is powered up. You can reset these channels, without switching off the bus : select the channel **MAX SPD** or **AVRG SPD** then press the ▼ key for 2 seconds.

1.3 Functions of the remote control keys

- **Low key**  and **High key** 

These keys allow to change the channel on display. They also allow to increase or reduce a data which is in the process of being modified.

-  **key**

Press this key to select the channel of the upper line or the channel of the bottom line.

-  **key**

This key allows to validate the settings you implement. It also allows to access the **filter**, **unit** and **calibration** sub-channels.

-  **key**

Press this key to exit the setting mode. Brief pressure on this key also allows to set the level of lighting.

-  **alarm key**

Brief pressure on this key allows to set the alarms.



1.4 Channel selection

The two display lines of the **Multifunction PERFORMANCE** or **Multifunction DL18** are independent. Configure the display according to your requirements :

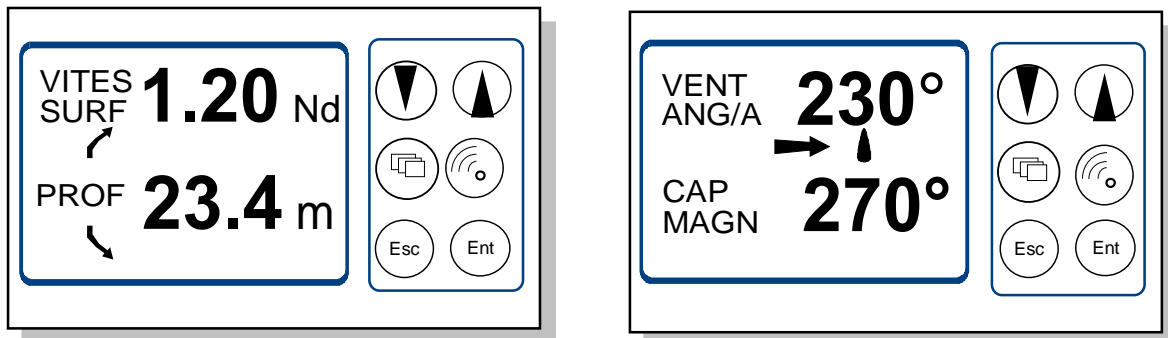
Examples of display :



Procedure

- Press  to select the channel of the upper line or the channel of the bottom line : the selected line flickers,
- using the  and  keys, select the channel you wish to display from the list,
- your new display setting is saved to the memory.

1.5 Page selection

10 page are saved in memory. To select one of these pages, press  and stop when the two line flick.

Using the  and  keys, select the page you wish to display.

1.6 What is a sub-channel ?

The sub-channels correspond to the setting and display parameters of the channels. For example, the sub-channels of the **surface speed** channel are:

- the setting of the **upper alarm** and the **lower alarm**,
- the measurement **unit** : in knots or in km/hr,
- the **filter** setting,
- the **offset** and the **calibration coefficient** for the calibration of the log-speedometer sensor.

The following chapters provide detailed explanations on how to access the sub-channels via the main channel and implement the settings.

1.7 Alarms setting

The setting of an alarm enables you to monitor the value of a channel. When the preset threshold is exceeded, a warning message is displayed and an audible alarm is activated. Thus, the setting of the alarms will allow you to supervise your **TOPLINE** installation effectively as well as the good operation of your boat. For example, you can set an upper threshold and a lower threshold on the **surface speed** channel.

The upper alarm is activated when the display is higher than the programmed threshold.

The lower alarm is activated when the display is lower than the programmed threshold.

To cancel the alarm of a channel, enter the value **0** in the upper alarm and the lower alarm.

Note that for angular channels such as **magnetic heading** or **wind angle**, the sub-channels of alarms are the **alarm base** and the **alarm range**.

CAUTION : The **air temperature** and **water temperature** channels have a distinctive feature. To cancel the alarm of these channels, enter the value **0**, when the unit is the degree Fahrenheit, or **-17.7**, when the unit is the degree Celsius.

1.7.1 Setting procedure

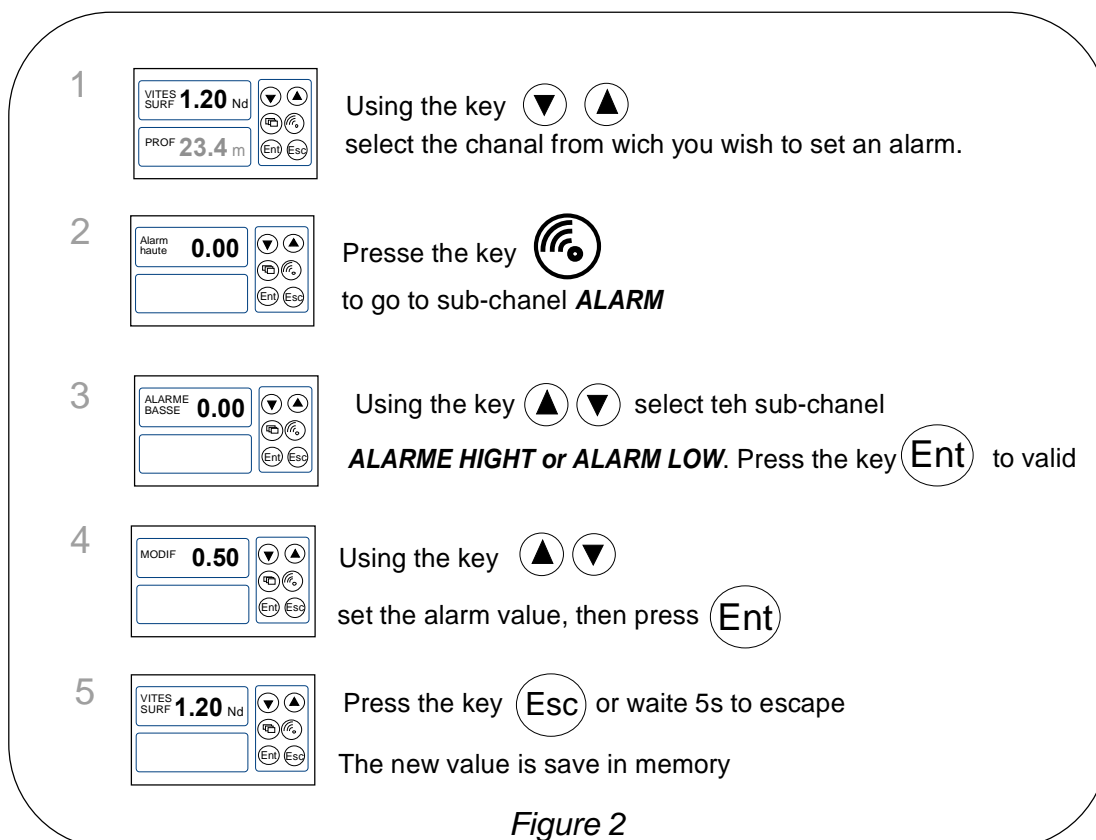
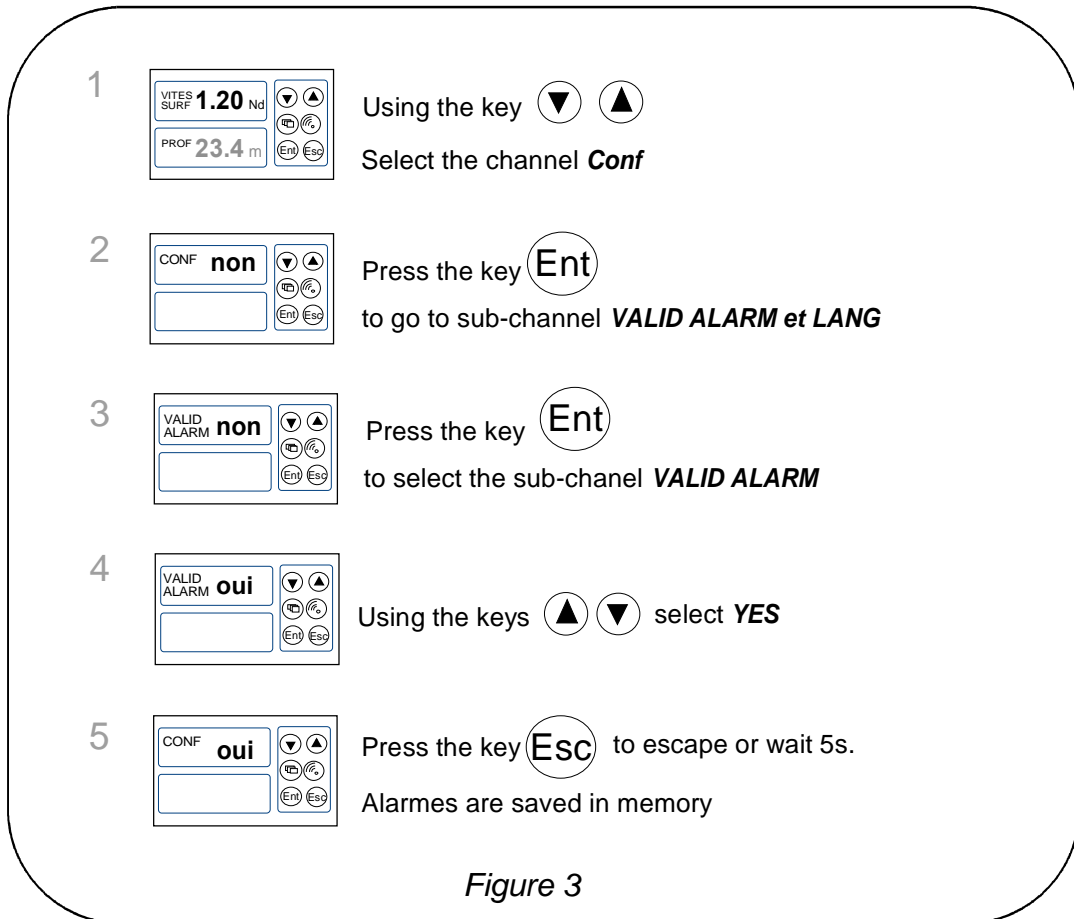

Figure 2

1.7.2 Procedure to activate the alarms

After having set the alarms, you can activate or disable all the alarms. When the alarms are activated, the following symbol is displayed in the upper right corner of the display :



Note that when an alarm is triggered, you can suspend the audible alarm for 10 minutes, by briefly pressing any key.

1.8 Filtering of the channels

The level of **filtering** of a channel determines the frequency of update of the data displayed.

For example, in rough sea when the boat moves significantly, it is useful to increase the filtering of the speed channel to stabilise the value displayed. Conversely, in calm sea, low filtering will be preferable to obtain a fast response of the display.

Filtering is adjustable between **1** and **32**, and the default value is **8**. The lower this value is, the higher the frequency of update is.

Filter setting procedure

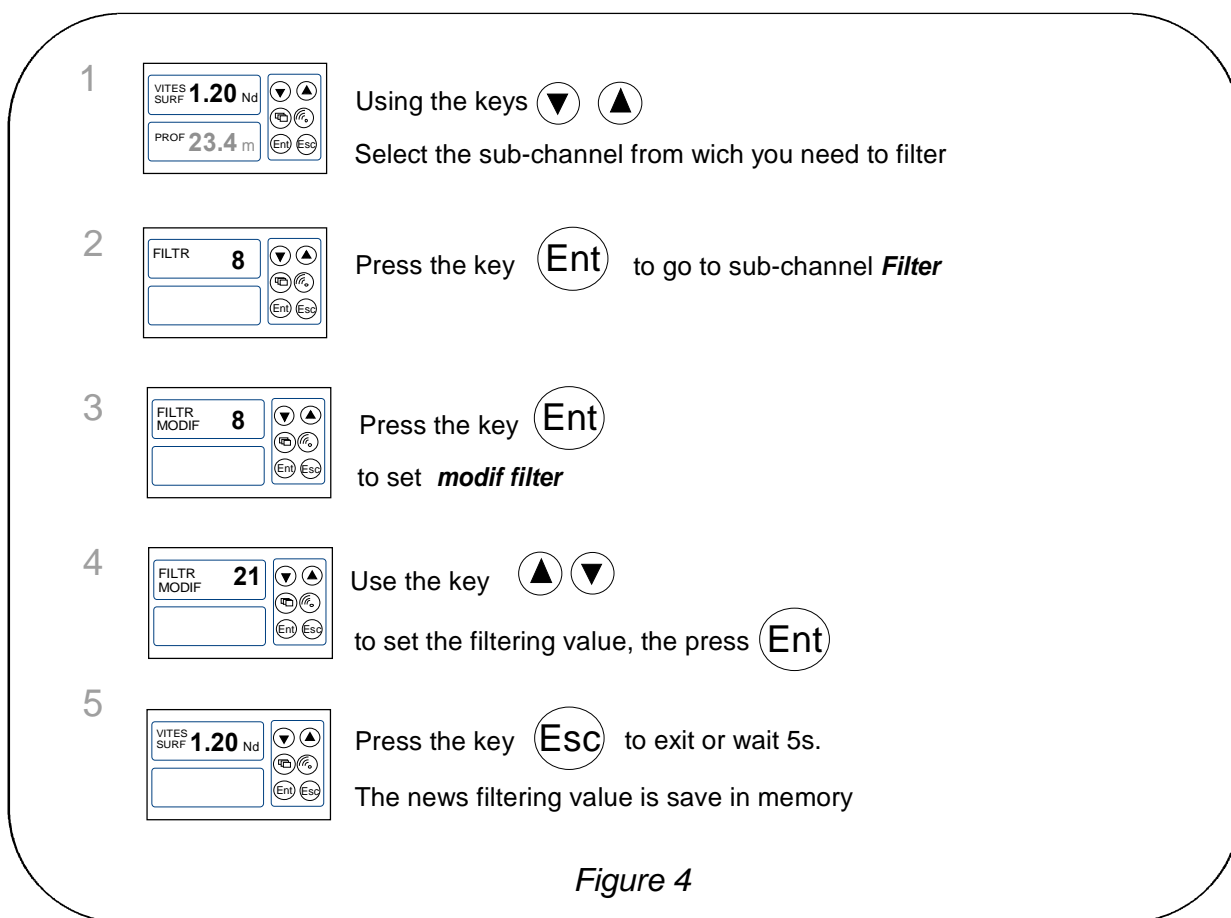

1.9 Lighting setting

The displays of the **TOPLINE** range have five levels of backlighting : 0 = no lighting, 1 corresponds to the minimum level of lighting and 4 to the maximum level. You have the option to set the level of lighting, either locally, or on every **TOPLINE** display of your installation :

Procedure

- Press **Esc** to access the lighting setting,
- using the **▼** and **▲** keys, set the level of lighting from **0** to **4**,
- to apply the setting to every display, press **Ent**,
- after 5s, the display automatically exits the setting mode.

1.10 Choice of the unit

You have the option to choose the display units of the channels :

- in knots or in km/hr for the log/speedometer and the bottom speed (GPS),
- in knots or m/s for the anemometer,
- in degree Fahrenheit or in degree Celsius for the temperature
- in meters or in feet for the sounder.

Unit setting procedure

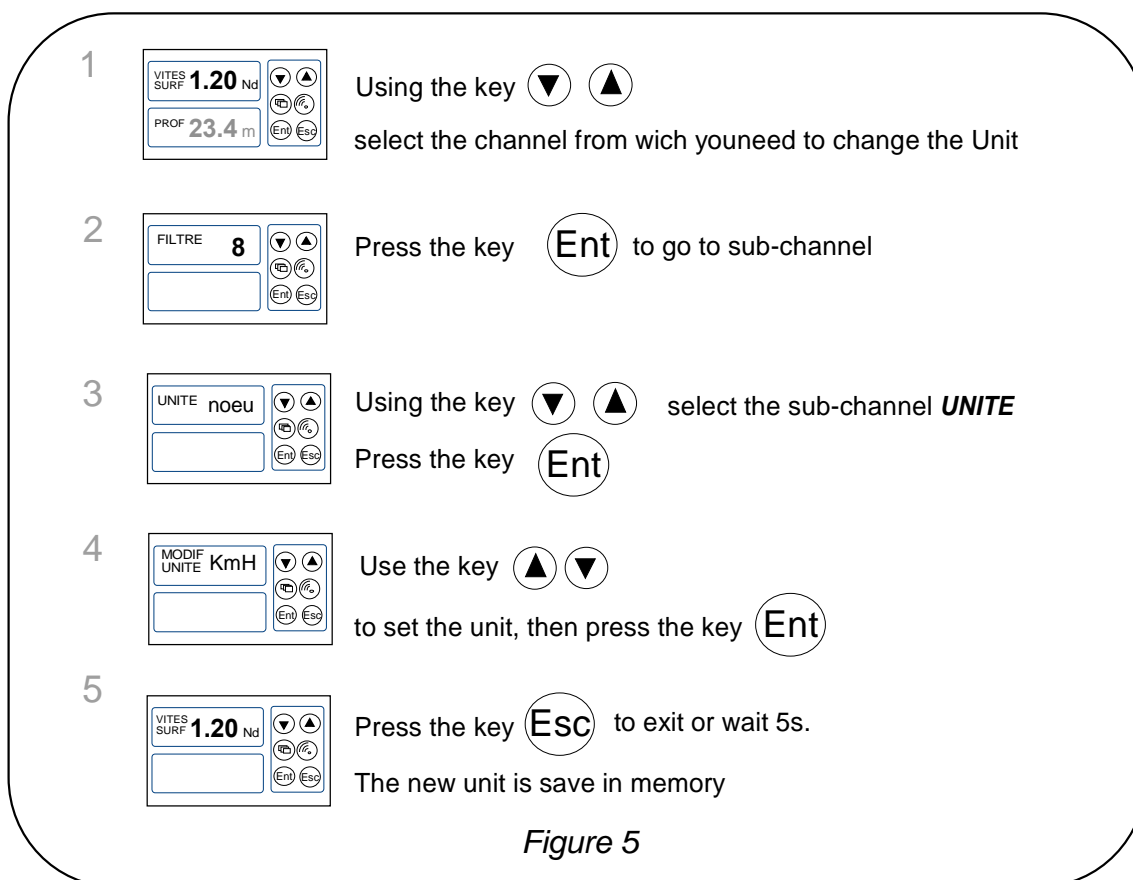





Figure 5

1.11 Zero setting of the daily log

The channels **daily log** and **total log** are at your disposal on your display.

You will use the **daily log** to count the number of nautical miles completed during a sailing leg. The value is kept in memory when the power supply of your installation is cut off. Resetting the **daily log** channel to zero will allow you to count the number of nautical miles of the following sailing leg.

Procedure to reset the daily log

- using the  and  keys, select the channel **day log**,
- then press the  key until the log is reset to zero.

The **total log** indicates the number of nautical miles completed since the installation of your **loch & sounder interface**. Only a complete initialisation of your **loch & sounder interface** allows to reset the **total log** to zero. It is performed by initialising the **surface speed** channel.

1.12 Choice of languages

You can configure the **PERFORMANCE** and the **DL18** in one of the six available languages : French, English, Italian, Spanish, German and Dutch.

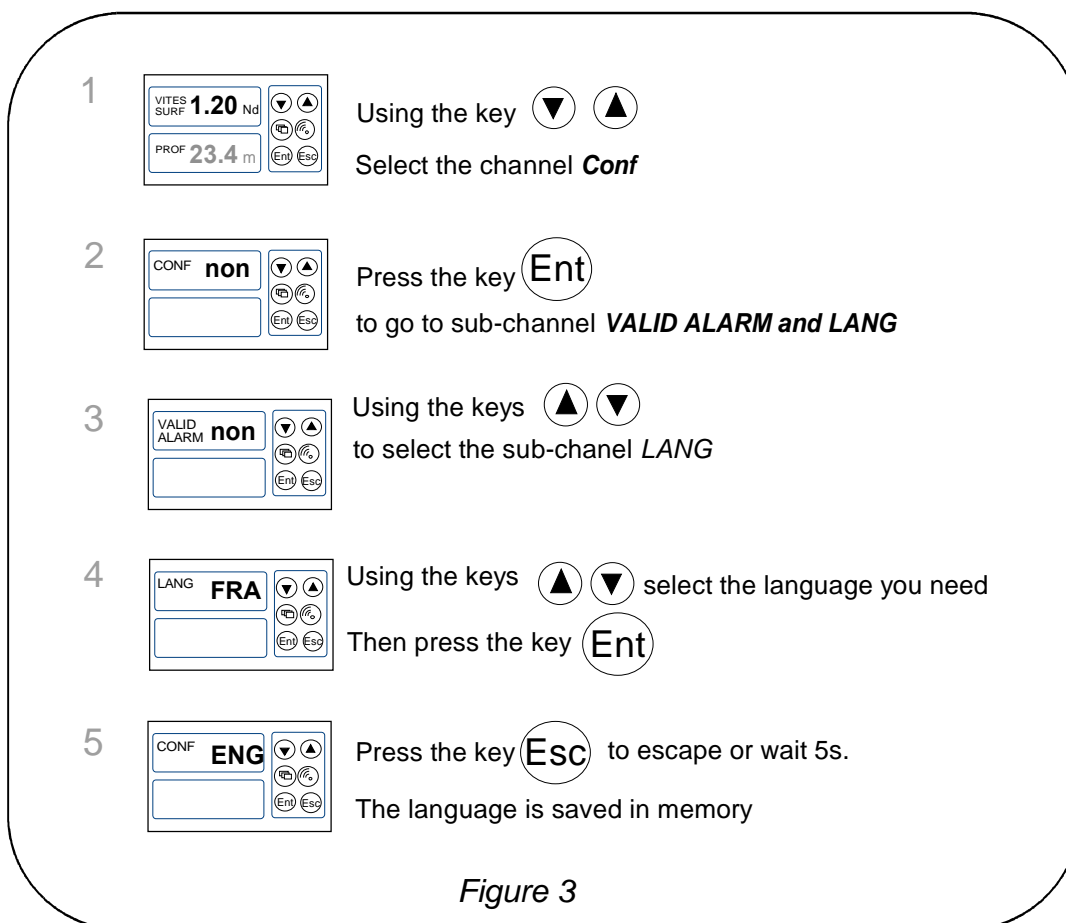

1.13 Use of the chronometer

The **Multifunction** includes a regatta chronometer. Times by default are T1= 6min and T2 = 4min.

1.13.1 Starting the chronometer

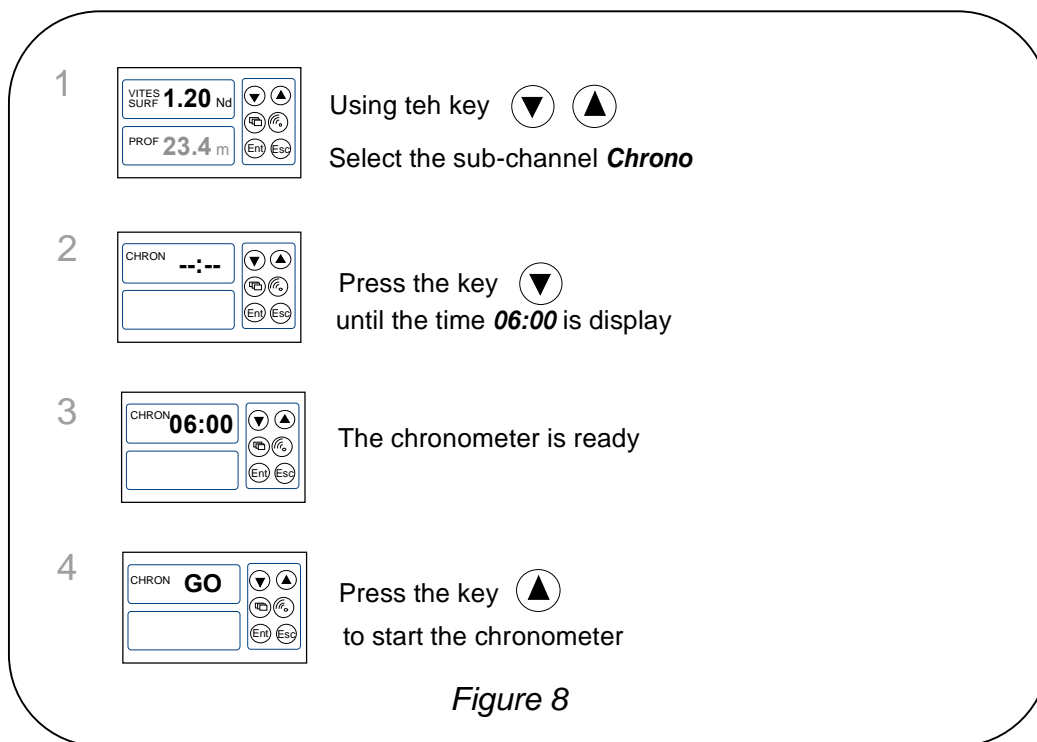



Note that if you did not start the chronometer exactly at the start signal, you can synchronise the chronometer countdown T2, at the intermediate time, by pressing the **▲** key. During the procedure, you can also return to T1 by pressing and holding the **▼** key. The chronometer then displays T1 = 6.00 minutes, for a new start.

1.13.2 Setting of T1 and T2

- Using the **▼** and **▲** key, select the **CHRONOMETER** channel,
- press **Ent** : the message **T1 init** is displayed,
- press **Ent** to select **T1 init**,
- change the value of T1 using the **▼** and **▲** keys, then validate with **Ent**,
- press **Ent** to select **T2 init**,
- change the value of T2 using the **▼** and **▲** keys, then validate with **Ent**,
- press **Ent** or wait for 5s to exit the setting mode.

1.13.3 Man over board function

Simultaneously press the  and , keys for 5 seconds, to activate the «Man Over Board» alarm. When a speedometer and a compass are connected to the **TOPLINE bus**, the displays then automatically indicate the estimated heading and distance to reach the man over board. If your installation only comprises a speedometer, then only the estimated distance will be displayed.

To disable the «Man Over Board» alarm, you must cut off the power supply of your **TOPLINE** installation.

1.14 Trend and position indicators

The **Multifunction Performance** displays trend and position indicators for different channels.

The trend indicators :

- The increase or decrease trend for the channels : surface speed, apparent wind speed, true wind speed, VMG, CMG, depth, cross-track error, water temperature, air temperature, speed towards waypoint
- The trend of left-hand or right-hand rotation for the channels : apparent wind angle, true wind angle, magnetic heading, heel, true wind direction, mast angle

The position indicators :

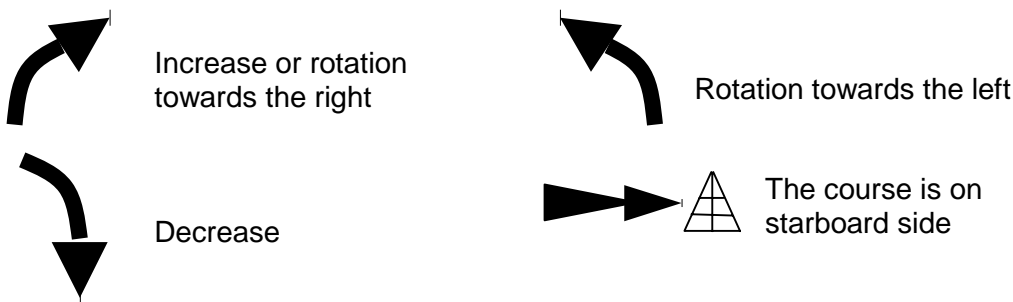

The wind direction indicator for the channels true wind, apparent wind, heel, helm angle, drift.

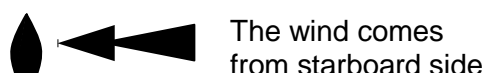

1.15 Technical specifications

- Power supply : 10 to 16VDC
- Consumption : 22mA without lighting and 90mA with lighting.
- Tightness : IP67
- Weight : 400g including cable
- Bus cable : $\varnothing 5.0 \pm 0.3$ – weight : 34 g/m.
- Dimensions : height = 97mm ; width = 147mm ; thickness = 25mm
- Operating temperature : -10°C to +50°C
- Storage temperature : -20°C to +60°C
- Horizontal viewing angle : superior to 120°
- Vertical viewing angle : superior to 90°
- Height of the characters displayed : 18 mm for the channel, and 6 mm for the identifier and the unit.

1.16 Software version

You can check the software version of the display. In order to do this, select the *CONF* channel, press and hold the  key. The software version is then displayed on the screen.

1.17 Diagnostic of 1st level troubleshooting.

This chapter can help you rapidly resolve minor problems which do not require the intervention of a specialist. Before contacting technical support, please check the troubleshooting table below.

Problem	Possible causes and solutions
The <i>Topline</i> installation does not detect the display	The bus cable is not or is badly connected to the terminal box : check the connection inside the terminal box. Check the state of the cables: they must not show any sign of wear or cut.
Your display indicates « <i>battery fault</i> ».	Check the voltage of your battery with a voltmeter : the operating voltage must be higher than 10VDC. Check the charge behaviour of your battery.
Your display indicates « <i>Data wire error</i> »	Check the connection of the black wire (data wire) inside the terminal box : it may have been connected to the earth or the 12V terminal by mistake.
Your display indicates « <i>collision error</i> »	It is possible that there are two master displays (at address 1) on your installation : check the addresses, if it is the case, reinitialise one of the displays.
Your display indicates « <i>Pan</i> » on a channel.	Check the sensor of this channel : it may be damaged or disconnected.
Your display indicates « <i>See bus error</i> » on a channel when you access the sub-channels.	Check the sensor of this channel, check the connection cable : it may be damaged or disconnected.
Your display indicates « <i>Error Eprom</i> ».	Reinitialise your display. If the error message continues, please contact your distributor.

If you do not manage to solve the problem, please contact your distributor.

1.18 *PERFORMANCE and DL18* initialisation : see chapter 3.6

2 SENSOR CALIBRATION

Every **nke** sensor is adjusted at the factory. However, a calibration is required to adapt the sensor to the specificities of your boat and to obtain an optimum measurement accuracy. Follow the calibration procedure below, by visualising the settings on a display.

Please refer to the installation notice of the **TOPLINE** sensor that you wish to calibrate.

2.1 Setting procedure for the calibration coefficient

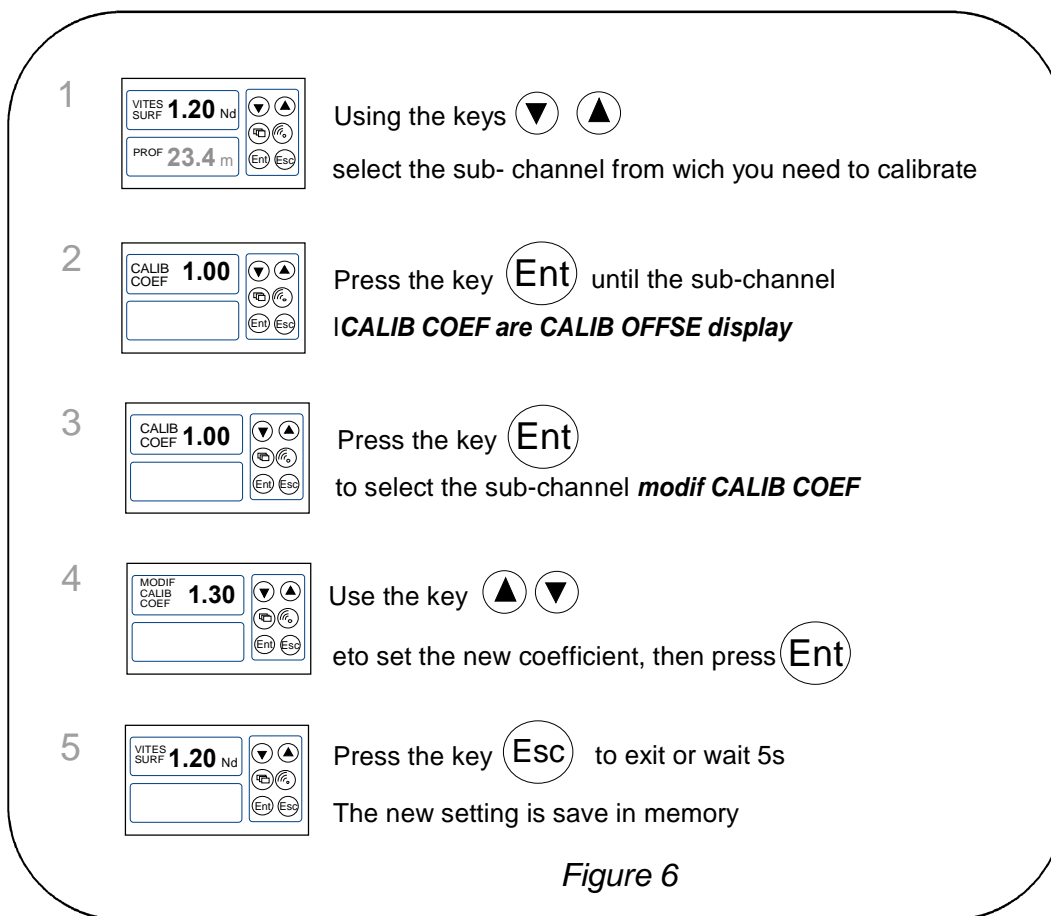

Figure 6

CAUTION : The **calib coef** parameter is a multiplier coefficient. This value must never be equal to zero. By default this coefficient is set to **1.00**. If it is not the case, before starting a calibration enter the value **1.00**.

2.2 Offset setting procedure

Follow the procedure above and select the sub-channel **OFFSET CALIB**.

Please note that by default, the value of the offset is **0**.



2.3 Autocompensation of the Fluxgate compass

Please refer to the user guide of the compass before performing the autocompensation procedure below.

In order to achieve a successful autocompensation, you must navigate :

- On smooth sea, with no current,
- away from large magnetic masses such as cargo boats.
- in an open area allowing the execution of a circle with a diameter approximately 5 times the length of the boat.
- at a constant speed of about 2 or 3 knots.

Procedure

1. Display the **magnetic heading** channel,
2. start to describe the circle, then launch the autocompensation procedure by pressing the  key for 2 seconds,
3. the display then sequentially indicates the non-compensated heading and dashes,
4. one single circle* is sufficient to perform the autocompensation correctly. The display then indicates that the autocompensation was successful : the code 3000 and dashes are intermittently displayed.
5. exit the autocompensation mode by pressing the  key for 2 seconds.

In case of problem during autocompensation, the display will signal the cause of the fault to the user by intermittently indicating the message PAN for 5 seconds, with the following code :

- code 1 : Cancellation at user request.
- code 2 : Detection of a gyration in the opposite direction. Start again clockwise.
- code 3 : Excessive variation between 2 heading measurements. Reduce the speed of your boat to 2 or 3 knots.
- code 4 : Angle correction higher than 20°. In this case, start the autocompensation procedure over.

In case of autocompensation error, the measurements are not saved to the memory and the compass resumes its normal operating mode.

** For the previous generation of compass, referenced as 90-60-005, at least three circles must be executed.*

3 INSTALLATION

This chapter describes the **Performance** and **DL18** installation and initialisation.

IMPORTANT :

- Read this guide entirely before starting the installation.
- The electrical connection on the **TOPLINE bus** must be carried out with the terminal box 90-60-417 (fitted with connection terminal for the NMEA input).
- Only use **TOPLINE bus** cable of the type 20-61-001.
- Any intervention on the **TOPLINE bus** must be carried out with the installation power switched off.

3.1 Packing list

- One **Multifunction** equipped with three meters of **TOPLINE bus** cable and a locking nut.
- One user guide.
- One protective cover.

3.2 List of accessories

- Standard terminal box TOPLINE bus : 90-60-121.
- White protective cover : 90-60-301

3.3 Installation precautions

Before starting the installation, take the time to choose the most appropriate place.

The **PERFORMANCE** and **DL18** location must be :

- so that the helmsman is able to easily read the data,
- placed in a location away from potential shocks,
- more than 40cm away from a magnetic compass,

3.4 Wall mounting

Make sure the location is clean, smooth and flat. Check that there is sufficient space behind the partition to make the cable run.

- perform the $\varnothing 14$ drilling at the centre of the 147mm x 97mm space,
- clean the mounting surface with alcohol,
- lay a thin silicone sealing joint around the mounting perimeter,
- introduce the cable in the $\varnothing 14$ drilled hole,
- position the display and tighten the fixing nut moderately.

CAUTION :

- When mounting the display, tighten the fixing nut moderately. Excessive tightening can cause the casing to break.
- Do not use glue putty to mount the display.

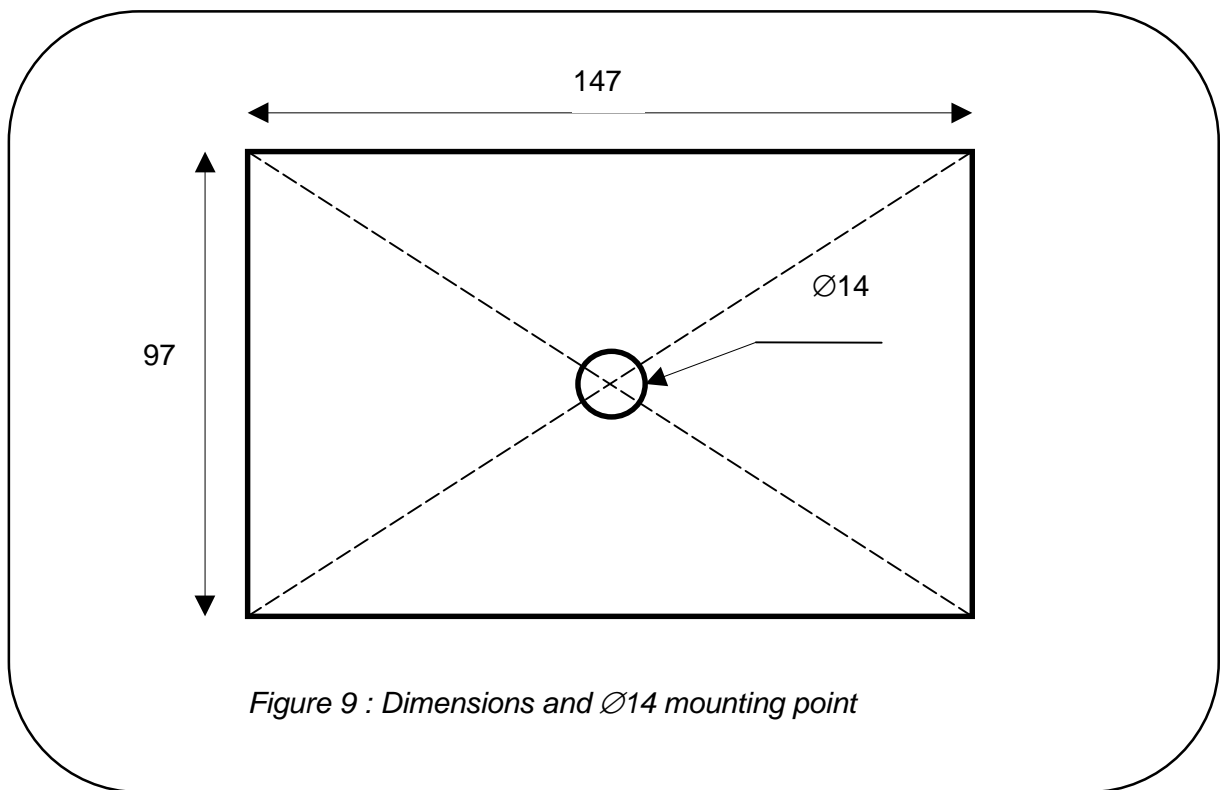
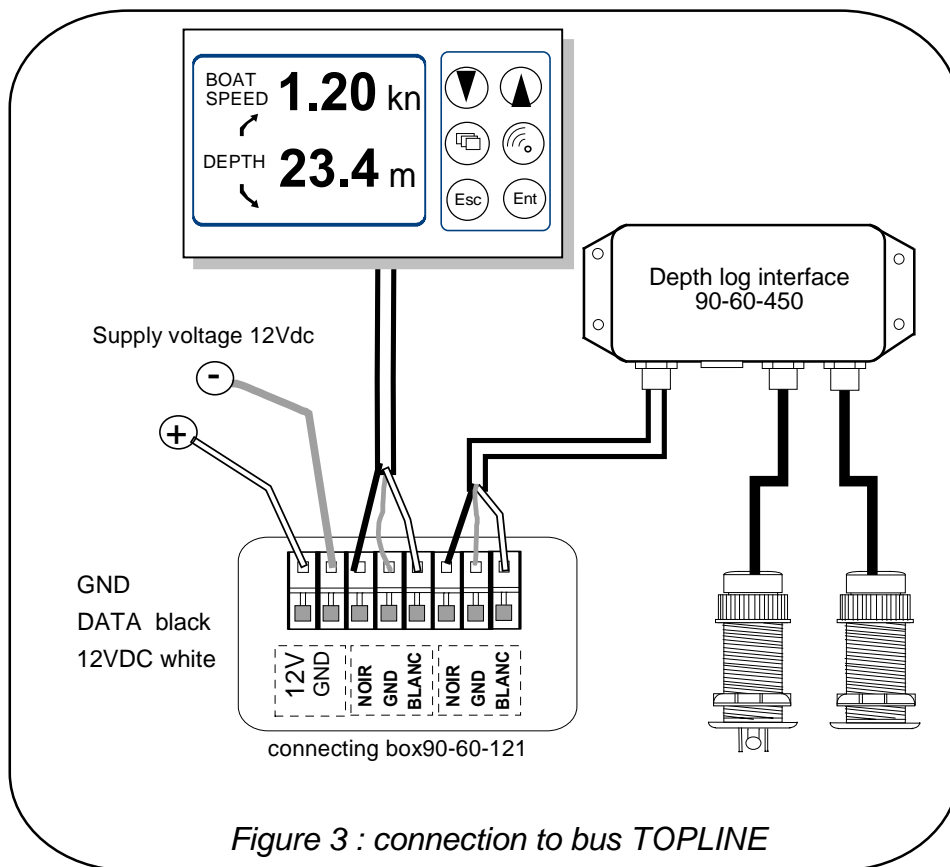

Figure 9 : Dimensions and $\text{Ø}14$ mounting point

3.5 Connection to the *Topline bus*

1. Make the bus cable run to the **TOPLINE** terminal box of your installation.
2. Connect the bus cable inside the terminal box.



If you reduce the length of the bus cable, strip and galvanise the wires before connecting them inside the terminal box.

3.6 **PERFORMANCE** and **DL18** initialisation

At first power-up, you must initialise the display so that an address is assigned to it. The display is delivered with the address set as **0**. During the initialisation, it will automatically insert itself in the list of instruments and displays of the **TOPLINE bus** of your installation :



- either as master, at the address **1**, if this address is available on the bus,
- or as slave, if the address 1 is taken by a master, at an available address comprised between **2** and **20**.

3.6.1 Initialisation procedure

- Power up your installation : the display briefly indicates «**DSPL ADDRES 0**»,
- press any key : the display indicates « **CREAT LIST** » or «**LIST**»,
- the display is then initialised.

3.6.2 Reinitialisation procedure

You may need to reinitialise the display, for example to have another address assigned to it.

- simultaneously press the  and  keys
- the display briefly indicates « **init ADDRES 0** »,
- press any key : the display indicates « **CREAT LIST** » or «**LIST**»,
- the display is then initialised.

